

# BRISTAN

TAPS & SHOWERS

## Installation Instructions & User Guide

Please leave these instructions with the end user

Product code: TY2 BF C (D1)

### Specifications

#### Dynamic Water Pressure

Min: 0.2 bar Max: 5.0 bar

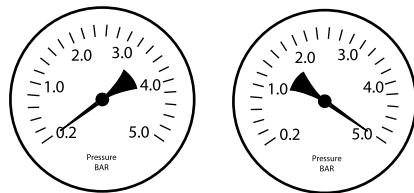

Maximum Static Pressure: 10.0 bar

#### Inlet Water Temperature

##### Cold Water Supply

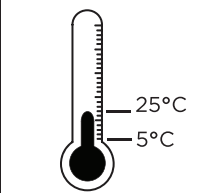

Min: 5°C Max: 25°C

##### Hot Water Supply

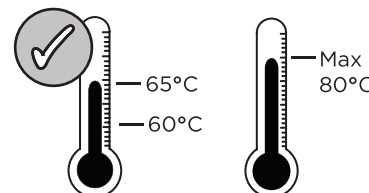

60-65°C recommended  
80°C Maximum

#### Inlet Connections

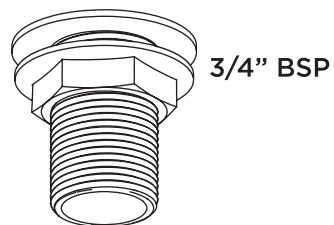

3/4" BSP

### Tools You'll Need



Phillips screwdriver Adjustable spanner Hexagonal Keys

### Prior to Installation

All products manufactured and supplied by Bristan are safe provided they are installed, used correctly and receive regular maintenance in accordance with these instructions.

This product has been tested to the Water Regulations Advisory Scheme (WRAS) and satisfies the requirements of the Water Supply (Water Fittings) Regulations 1999 and current bylaws. For full Installation Requirements & Notes (IRN) please visit [wras.co.uk/directory](http://wras.co.uk/directory).

We recommend isolation valves to be fitted to the inlet water supplies to ensure ease of future maintenance.

Before installing these taps the water supply must be thoroughly flushed in order to remove any swarf, solder etc.

This product must not be modified in any way as this will invalidate the guarantee.

### Pack Contents

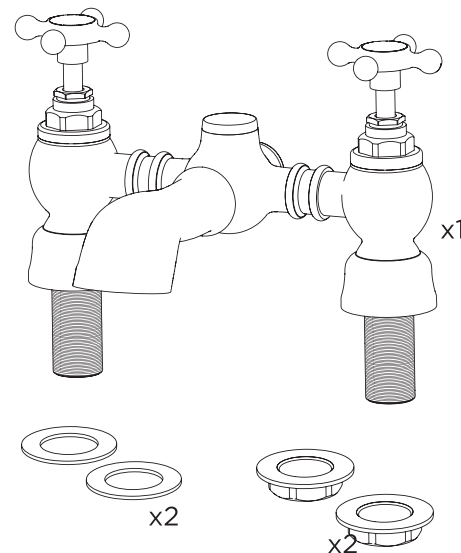

### Spare Parts

To replace any spare parts for your tap, why not scan the QR Code or visit [www.bristan.com](http://www.bristan.com) and search for your product.



### Installation

1

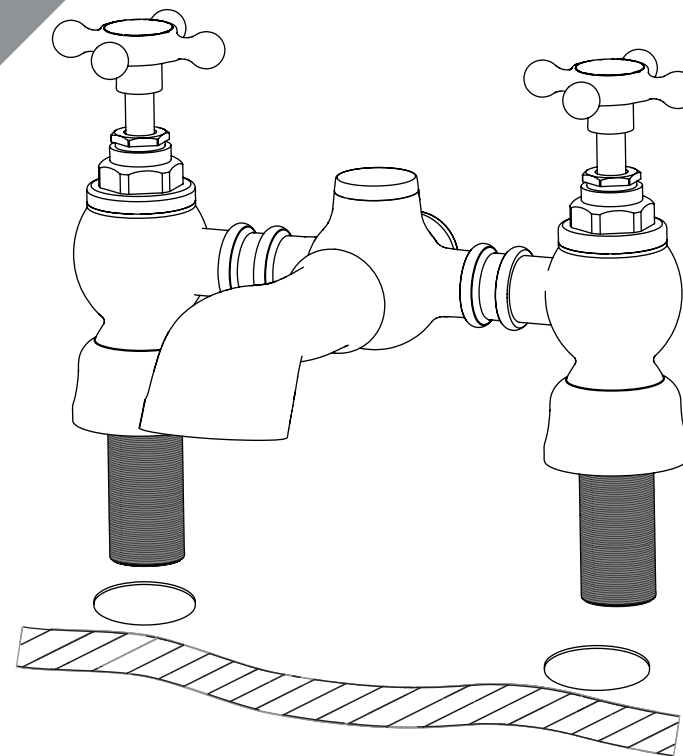

Fit the filler to the bath.

2

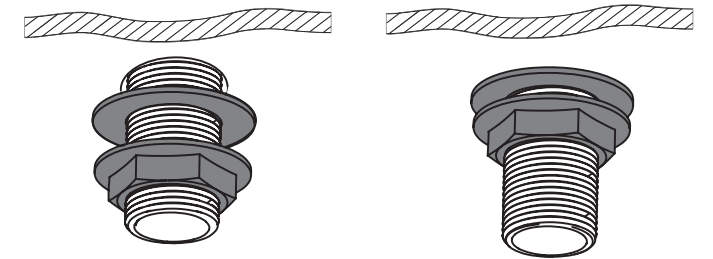

Secure the taps to the bath by using the washer and metal backnut below the bath.

Connect the water supplies.



**REMEMBER**  
Hot on the left, cold on the right!

3

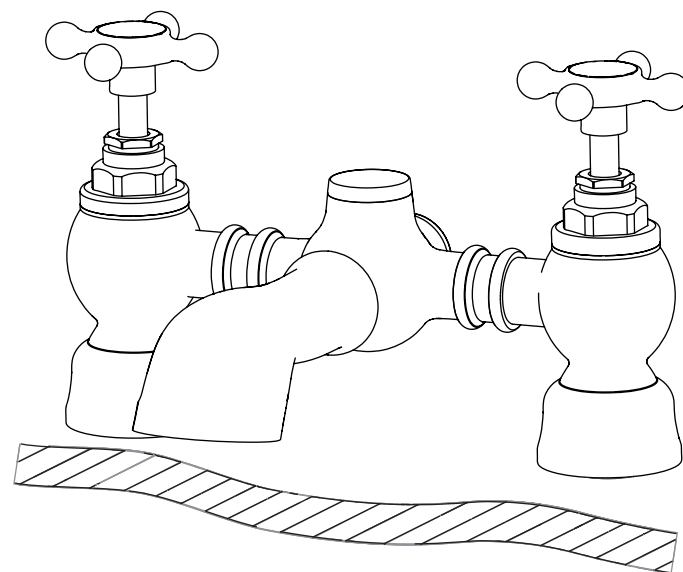

Connect the hot and cold water supplies to the threaded tails.

4

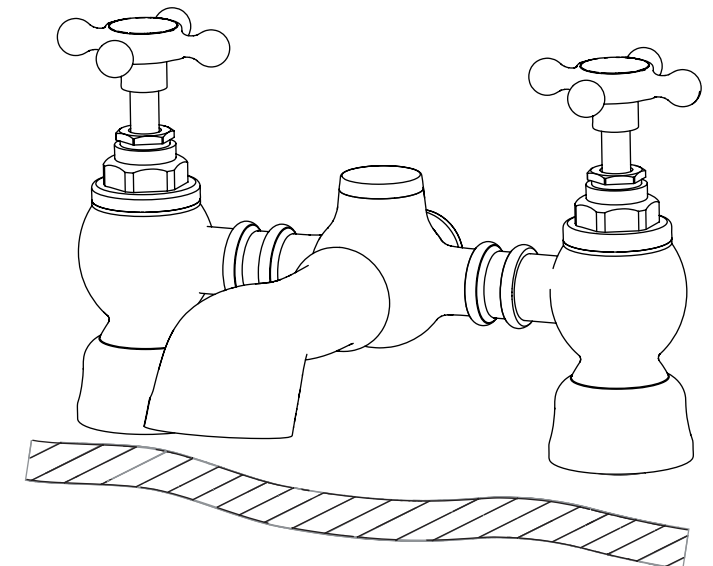

Turn on water supply.

**IMPORTANT**  
Turn on water supply for a few minutes and check all joints and connections for any leaks.

## Operation

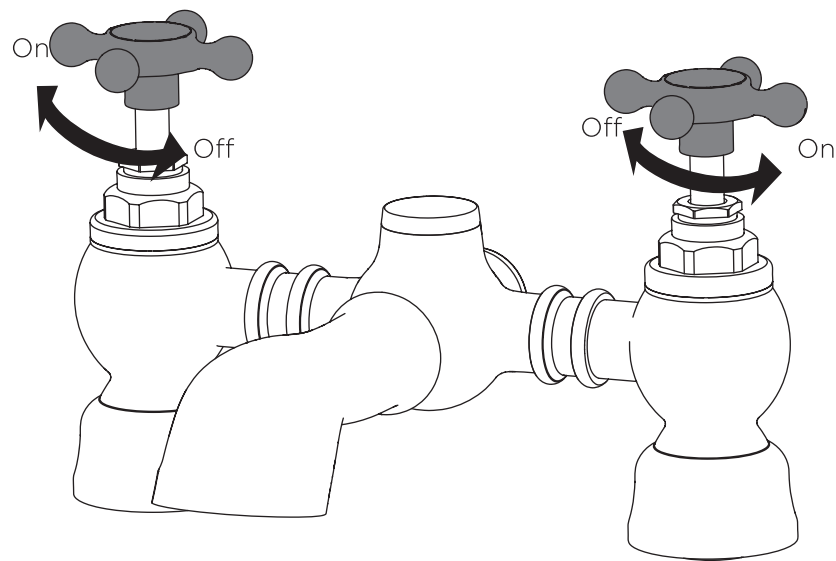

## General Cleaning

Bristan products are made from premium materials, with hand polishing and electroplated finishes.

Your taps or shower should be regularly cleaned with warm water, a mild pH-neutral liquid soap, and polished with a soft cloth. Any residues from soap, toothpaste, shampoos and shower gels can cause blemishes if not rinsed off straight after use.

Household bleaches and cleaners contain harsh chemicals and may damage the surface finish. Avoid using abrasive cloths, scouring pads, scrub sponges, steel wool or anything similar.

Some surfaces such as nickel and pewter may be affected by the dye found in some cloths, so it is also important to avoid hanging cloths on spouts.

## Troubleshooting

Symptom	Cause	Remedy
No flow or low flow rate	Partially closed isolation valve.	Open isolation valve.
	Instantaneous water heater cycles on and off as flow rate or pressure is too low.	Increase water flow rate or pressure through system.
	Head of water is below the minimum distance required.	Refer to specification for minimum distance required.
	Hot or cold water being drawn off elsewhere causing pressure changes or instantaneous boiler temperature changes.	Do not use other water outlets when using the taps.
Water dripping from taps	Airlock or partial blockage in the supply pipework.	Flush through pipework to ensure removal of debris and any airlocks.
	This is normal for a short time after using the taps.	This is caused by residual water tension, the build up of water in the tap body.
Taps do not turn on	If water continues to drip, possibly due to the ceramic disc valves	Remove valves and clean, refer to 'Maintenance' section before starting any maintenance.
	Closed isolation valve.	Open isolation valve.
	Mains water supply turned off.	Turn on mains water supply.

## Maintenance - Cartridge Cleaning

**1** Loosen the handle grub screw.

**2** Remove the handle from the spline adaptor.

**3** Remove the screw, gasket, spline adaptor and the shroud.

**4** Unscrew the valve using an adjustable spanner.

Place cartridge in a suitable solution and soak until fully de-scaled.

**5** Rinse with water and replace valve, shroud, spline adaptor, gasket, screw and handle.

**6** Tighten grub screw.

## Notes

Please use this space for any notes you or your installer may have regarding the installation/plumbing of this product.

At Bristan, we want to make things as easy as possible for our customers. That's why we offer solid guarantees on all our products, effective from the date of purchase, to give you peace of mind.

To start your free guarantee simply scan the QR code and register your product. Alternatively visit [www.bristan.com/register](http://www.bristan.com/register) to register your product via a computer.

For full guarantee terms and conditions visit [www.bristan.com/guarantees](http://www.bristan.com/guarantees).



*We Know & We Care*